

Milesight

# AI Weather-proof Mini Bullet Network Camera

NDAA 

IP67

IK10



DATASHEET

## KEY FEATURES

- ▶ NDAA Compliance (The fully NDAA-compliant products are well suited for government, defense and a range of projects subject to the NDAA.)
- ▶ Powerful IR LEDs (Equipped with 3rd generation dot matrix IR LEDs, guaranteeing excellent image quality, long lifespan and energy efficiency.)
- ▶ 120dB Super WDR (Excellent performance even when the ratio of the luminosity of brightest and darkest is up to 120dB.)
- ▶ Advanced Functions (Boasting to support various advanced functions such as HLC, ROI.)
- ▶ 256G (Supporting ultra-large external microSD/SDHC/SDXC card storage up to 256G.)
- ▶ Adjustable 3-Axis Bracket (Providing a robust mounting platform for angle adjustments on a 3-axis plane.)
- ▶ Smart Stream (Bandwidth, storage and bit rate are saved with Smart Stream On, eg, H.265+ saves 70%~80% bandwidth that of H.264.)

## AI Video Analytics

- 8 intelligent VCA modes powered by AI engine, which can intelligently filter objects to focus on human and vehicle detection.
- People Counting technology provides high accuracy and real-time data based on AI algorithm with statistic reports.



## 0.005Lux Ultra Low-light

The starlight camera is able to deliver high detailed color images even in low light environment reaching 0.005Lux(Color) or 0Lux(B/W), and near infrared light environments without any supplementary lighting.

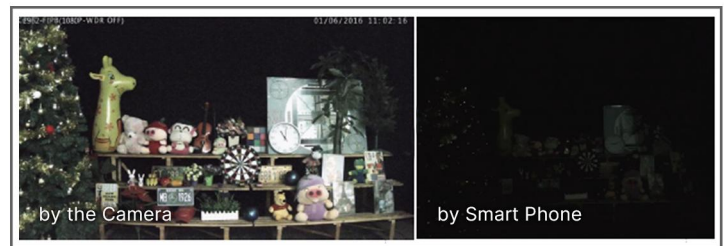

## 30fps@4K

Providing 4K HD resolution with frame rate of 30fps, the camera performs well in catching detailed image regardless of the moving speed.



## IP67&IK10

Supporting IP67-rated weather proofing and IK10-rated vandal proof which are the leading level of the industry, the camera is well protected against adverse impact to ensure the performance.



# AI Weather-proof Mini Bullet Network Camera



	Model	MS-C2963-RPA (2MP)	MS-C5363-PA (5MP)	MS-C8163-PA (4K)
<b>Camera</b>	Image Sensor	1/2.8" Progressive Scan CMOS		
	Min. Illumination	Color: 0.005Lux@F1.6 B/W: 0Lux with IR on	Color: 0.008Lux@F1.6 B/W: 0Lux with IR on	Color: 0.012Lux@F1.6 B/W: 0Lux with IR on
	WDR	120dB Super WDR		
	Lens	4mm/2.8mm/6mm@F1.6		
	Mount	M12		
	Field of View	H91°/D106°/V50°(4mm) H111°/D128°/V61°(2.8mm) H55°/D63°/V32°(6mm)	H86°/D108°/V63°(4mm) H105°/D131°/V78°(2.8mm) H52°/D63°/V40°(6mm)	H91°/D106°/V50°(4mm) H110°/D126°/V60°(2.8mm) H55°/D63°/V32°(6mm)
	Shutter Time	1/100000s~1s		
	IR Distance	Up to 50m		
	Day/Night Mode	Day/Night/Auto/Customize/Schedule		
	S/N	>55dB		
<b>Video</b>	Max. Image Resolution	1920x1080	2592x1944	3840x2160
	Primary Stream	60Hz: 60fps@(1920x1080, 1280x960, 1280x720, 704x576) 50Hz: 50fps@(1920x1080, 1280x960, 1280x720, 704x576)	60Hz: 30fps@(2592x1944, 2592x1520, 2048x1536, 1920x1080, 1280x960, 1280x720, 704x576) 50Hz: 25fps@(2592x1944, 2592x1520, 2048x1536, 1920x1080, 1280x960, 1280x720, 704x576)	60Hz: 30fps@(3840x2160, 3072x2048, 2592x1944, 2592x1520, 2048x1536, 1920x1080, 1280x960, 1280x720, 704x576) 50Hz: 25fps@(3840x2160, 3072x2048, 2592x1944, 2592x1520, 2048x1536, 1920x1080, 1280x960, 1280x720, 704x576)
	Secondary Stream	60Hz: 60fps@(704x576, 640x480, 640x360, 352x288, 320x240) 50Hz: 50fps@(704x576, 640x480, 640x360, 352x288, 320x240)	60Hz: 30fps@(704x576, 640x480, 640x360, 352x288, 320x240) 50Hz: 25fps@(704x576, 640x480, 640x360, 352x288, 320x240)	
	Tertiary Stream	60Hz: 30fps@(1280x720, 704x576, 640x480, 640x360, 352x288, 320x240) 50Hz: 25fps@(1280x720, 704x576, 640x480, 640x360, 352x288, 320x240)		
	Video Compression	H.265+/H.265(HEVC)/H.264+/H.264/MJPEG		
	Video Bit Rate	16Kbps~16Mbps(CBR/VBR Adjustable)		
	Privacy Masking	Up to 24 areas		
	ROI	Up to 8 areas		
Image Setting	Brightness/Contrast/Saturation/Sharpness			
<b>Interface</b>	Ethernet	1*RJ45 10M/100M Ethernet Port		
	Audio I/O	1/1 (Multi-interface Version)		
	Alarm I/O	1/1 (Multi-interface Version)		

# AI Weather-proof Mini Bullet Network Camera



<b>Network</b>	Network Storage	NAS(Support NFS, SMB/CIFS), ANR
	Protocol	IPv4/IPv6, ARP, TCP, UDP, RTCP, RTP, RTSP, RTMP, HTTP, HTTPS, DNS, DDNS, DHCP, FTP, NTP, SMTP, SNMP, UPnP, Bonjour, SIP, PPPoE, VLAN, 802.1x, QoS, IGMP, ICMP, SSL
<b>Audio</b>	Audio Compression	G.711/AAC/G.722/G.726
	Audio Sampling Rate	8/16/32/44.1/48KHz
	Audio Bit Rate	16~256kbps
	Two-way Audio	Support
<b>Intelligent Analytics</b>	Video Analysis	Region Entrance, Region Exiting, Advanced Motion Detection, Tamper Detection, Line Crossing, Loitering, Object Left, Object Removed
	People Counting& Report	Count the number of people entering or exiting, up to 4 detection areas for regional people counting
<b>System</b>	Storage	Support microSD/SDHC/SDXC Card Local Storage, up to 256G
	Advanced Function	Heat Map, BLC, HLC, 2D DNR, 3D DNR, AWB, IP Address Filtering, AGC, Anti-flicker, Corridor Mode, Deblur, Watermark
	SIP/VoIP Support	Yes, Voice & Video-over-IP
	Event Trigger	Motion Detection, Network Disconnection, etc.; Motion Detection, Network Disconnection, External Input, Audio Alarm, etc. (Multi-interface Version)
	Event Action	FTP Upload, SMTP Upload, SD Card Record, SIP Phone, HTTP Notification, etc.; FTP Upload, SMTP Upload, SD Card Record, External Output, SIP Phone, HTTP Notification, etc. (Multi-interface Version)
	System Compatibility	ONVIF Profile G & Q & S & T, API
<b>General</b>	Working Temperature	-40°C~60°C
	Working Humidity	0~90%(Non-condensing)
	Power Supply	PoE (802.3af); PoE (802.3af) / DC 12V ± 10% (Multi-interface Version)
	Power Consumption	4W MAX 9W MAX (With IR on)      5W MAX 9W MAX (With IR on)
	Weather Proof	Up to IP67-rated for Weather-resistant Performance
	Housing	Vandal-proof IK10-rated Metal Housing
	Weight	750g
	Dimensions	Φ76mmX214.5mm
	Warranty	3/5 Years

# AI Weather-proof Mini Bullet Network Camera



## Structure Diagrams

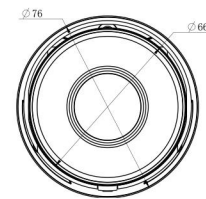
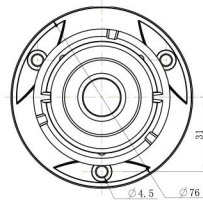
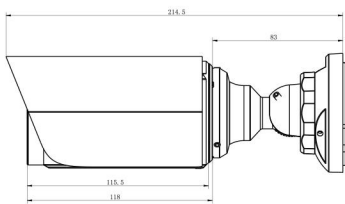
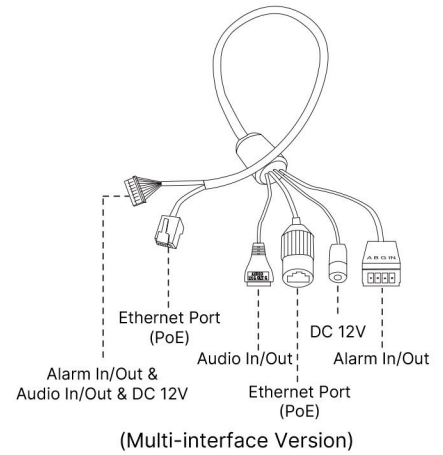
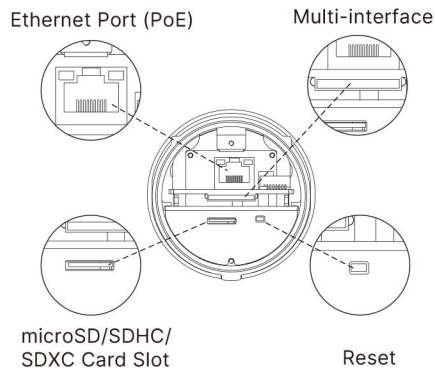
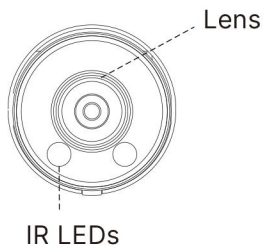

Units: mm

## Accessories Support

A01 Pole Mount

Weight: 720g  
Dimensions: 170\*51.5\*152.6mm



A03 External Corner Bracket

Weight: 900g  
Dimensions: 170\*152.5\*76.3mm



A63 Junction Box

Weight: 620g  
Dimensions: 134\*126\*40mm



**Milesight Technology** | [www.milesight.com](http://www.milesight.com)  
Contact Us: [sales@milesight.com](mailto:sales@milesight.com) [support@milesight.com](mailto:support@milesight.com)

Add: 220 NE 51st Street, Oakland Park, Florida 33334, USA  
Tel: +1-800-561-0485

Add: 925, Anyang SK V1 Center, LS-ro 116beon-gil, Dongan-gu, Anvang-si, Korea  
Tel: +82-31-990-7732

Add: Building C09, Software Park Phase III, Xiamen 361024, Fujian, China  
Tel: +86-592-5922772

