

# Milesight

## AI IR Mini Dome Network Camera

NDAA 



DATASHEET

### KEY FEATURES

- ▶ NDAA Compliance (The fully NDAA-compliant products are well suited for government, defense and a range of projects subject to the NDAA.)
- ▶ 0.005Lux Starlight (Deliver high detailed color images even in low light environment reaching 0.005Lux.)
- ▶ Advanced Functions (Boasting to support various advanced functions such as HLC, Defog, ROI.)
- ▶ Built-in Microphone (Supporting audio function to hear what is happening in front of the camera.)
- ▶ SIP (Session Initiation Protocol. Providing audio/alarm/intercom and video streaming for mobile phones and video phones.)
- ▶ 3-Axis Mechanical Design (Featuring 3-axis mechanical design for fast and easy adjustment of the camera's viewing angle.)
- ▶ 256G (Supporting ultra-large external microSD/SDHC/SDXC card storage up to 256G.)
- ▶ Smart Stream (Bandwidth, storage and bit rate save with Smart Stream ON, eg, H.265+ saves 70%~80% bandwidth of H.264.)

### AI Video Analytics

The AI Camera Series can intelligently filter objects to focus on human and vehicle detection in multiple events such as Region Entrance, Region Exiting, Loitering, Advanced Motion Detection, etc.



### 120dB Super WDR

Sensor-based WDR technology allows the camera to record greater scene details with true color reproduction even under the extreme back light and high contrast conditions. The ratio that the brightest light signal values divided by the darkest light signal values is up to 120dB.

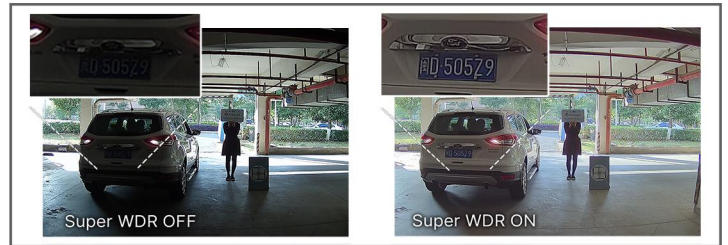

### 4K Video Viewing Experience

The camera performs well in catching detailed image with 4K HD resolution regardless of the moving speed.

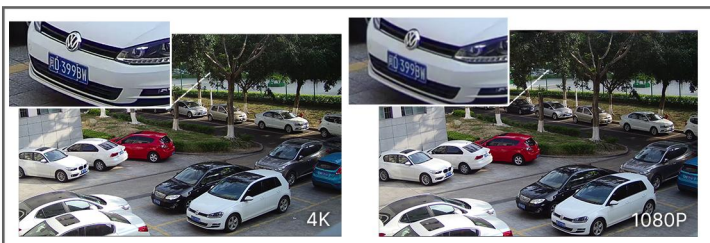

### Easy Installation & Adjustment

With a built-in RJ45 port, PoE functionality and 3-axis mechanical design, the installation steps of IR Mini Dome Camera are as easy as ABC.

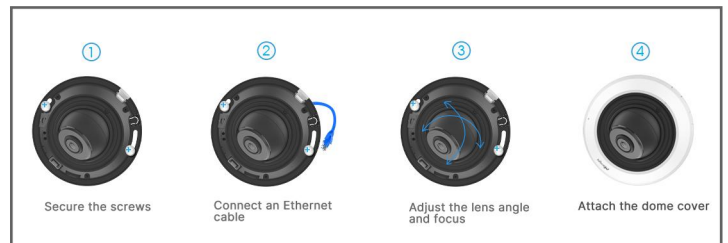

# AI IR Mini Dome Network Camera



	Model	MS-C2983-(R)PD (2MP)	MS-C5383-PD (5MP)	MS-C8183-(S)PD (4K)
<b>Camera</b>	Image Sensor	1/2.8" Progressive Scan CMOS		
	Min. Illumination	Color: 0.005Lux@F1.6 B/W: 0Lux with IR on	Color: 0.008Lux@F1.6 B/W: 0Lux with IR on	Color: 0.012Lux@F1.6 B/W: 0Lux with IR on
	WDR	120dB Super WDR		
	Lens	2.8mm/4mm/6mm@F1.6		
	Mount	M12		
	Field of View	H111°/D128°/V61°(2.8mm) H91°/D106°/V50°(4mm) H55°/D63°/V32°(6mm)	H105°/D131°/V78°(2.8mm) H86°/D108°/V63°(4mm) H52°/D63°/V40°(6mm)	H110°/D126°/V60°(2.8mm) H91°/D106°/V50°(4mm) H55°/D63°/V32°(6mm)
	Shutter Time	1/100000s~1s		
	IR Distance	Up to 20m		
	Day/Night Mode	Day/Night/Auto/Customize/Schedule		
	S/N	>55dB		
<b>Video</b>	Max. Image Resolution	1920x1080	2592x1944	3840x2160
	Primary Stream	60Hz: <b>60fps@(1920x1080)(Optional for R Series)</b> , 30fps@(1920x1080, 1280x960, 1280x720, 704x576) 50Hz: <b>50fps@(1920x1080)(Optional for R Series)</b> , 25fps@(1920x1080, 1280x960, 1280x720, 704x576)	60Hz: 30fps@(2592x1944, 2048x1536, 1920x1080, 1280x960, 1280x720, 704x576) 50Hz: 25fps@(2592x1944, 2048x1536, 1920x1080, 1280x960, 1280x720, 704x576)	60Hz/50Hz: 30fps@(3840x2160, 3072x2048, 2592x1944, 2592x1520, 2048x1536, 1920x1080, 1280x960, 1280x720, 704x576), 20fps@(3840x2160)(Optional for S Series)
	Secondary Stream	60Hz: 30fps@(704x576, 640x480, 640x360, 352x288) 50Hz: 25fps@(704x576, 640x480, 640x360, 352x288)	60Hz: 30fps@(704x576, 640x480, 640x360, 352x288) 50Hz: 25fps@(704x576, 640x480, 640x360, 352x288)	
	Tertiary Stream	60Hz: 30fps@(1280x720, 704x576, 640x480, 640x360, 352x288) 50Hz: 25fps@(1280x720, 704x576, 640x480, 640x360, 352x288)		
	Video Compression	H.265+/H.265(HEVC)/H.264+/H.264/MJPEG		
	Video Bit Rate	16Kbps~16Mbps(CBR/VBR Adjustable)		
	Privacy Masking	Up to 4 areas		
	ROI	Up to 8 areas		
	Image Setting	Brightness/Contrast/Saturation/Sharpness		
<b>Interface</b>	Ethernet	1*RJ45 10M/100M Ethernet Port		
	Audio Interface	Built-in Microphone		
<b>Network</b>	Network Storage	NAS(Support NFS, SMB/CIFS), ANR		
	Protocol	IPv4/IPv6, ARP, TCP, UDP, RTCP, RTP, RTSP, HTTP, HTTPS, DNS, DDNS, DHCP, FTP, NTP, SMTP, SNMP, UPnP, Bonjour, SIP, PPPoE, VLAN, 802.1x, QoS, IGMP, ICMP, SSL		

# AI IR Mini Dome Network Camera



<b>Audio</b>	Audio Compression	G.711/AAC/G.722/G.726		
	Audio Sampling Rate	8/16/32/48KHz		
	Audio Bit Rate	16~256kbps		
	Two-way Audio	N/A		
<b>Intelligent Analytics</b>	Video Analysis	Region Entrance, Region Exiting, Advanced Motion Detection, Tamper Detection, Line Crossing, Loitering, Object Left, Object Removed		
<b>System</b>	Storage	Support microSD/SDHC/SDXC Card Local Storage, up to 256G		
	Advanced Function	BLC, HLC, 2D DNR, 3D DNR, Defog, AWB, IP Address Filtering, AGC, Anti-flicker, Corridor Mode, Deblur		
	SIP/VoIP Support	Yes, Voice & Video-over-IP		
	Event Trigger	Motion Detection, Network Disconnection, Audio Alarm, etc.		
	Event Action	FTP Upload, SMTP Upload, SD Card Record, SIP Phone, HTTP Notification, etc.		
	System Compatibility	ONVIF Profile G & Q & S & T, API		
<b>General</b>	Working Temperature	-40°C~60°C		
	Working Humidity	0~90%(Non-condensing)		
	Power Supply	PoE (802.3af)		
	Power Consumption	2.6W MAX 4.6W MAX (With IR on)	3.3W MAX 5W MAX (With IR on)	3.7W MAX 5.4W MAX (With IR on)
	Weight	200g		
	Dimensions	Ø97.8mmX57.9mm		
	Warranty	3/5 Years		



# AI IR Mini Dome Network Camera



## Structure Diagrams

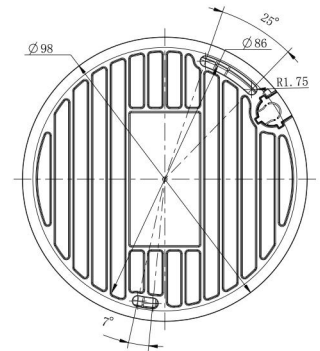
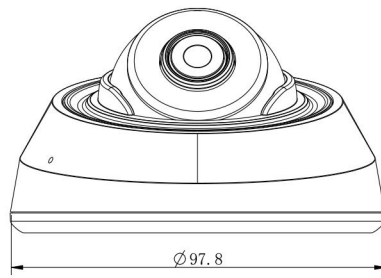
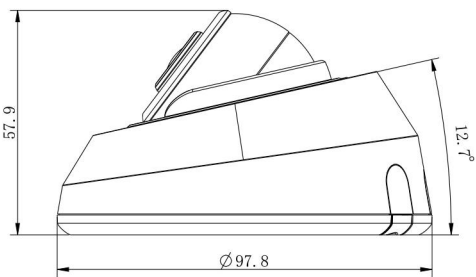
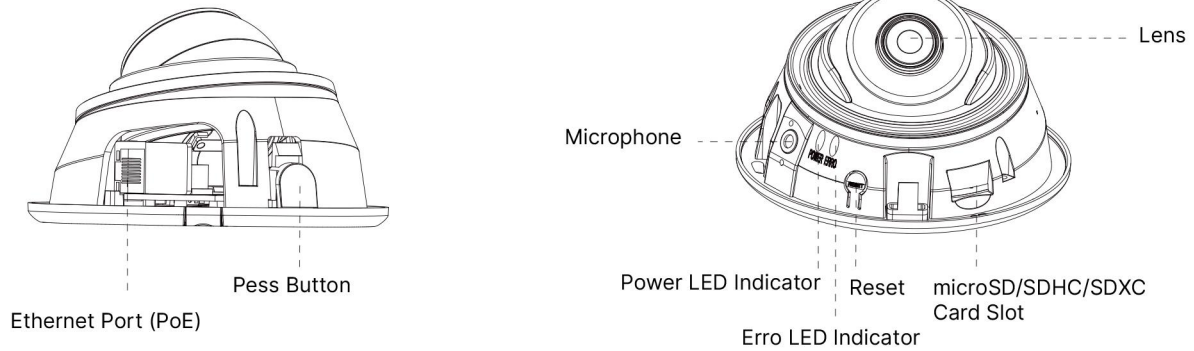

Units: mm

## Accessories Support

### A01 Pole Mount

Weight: 720g  
Dimensions: 170\*51.5\*152.6mm



### A03 External Corner Bracket

Weight: 900g  
Dimensions: 170\*152.5\*76.3mm



### A71 Wall Mount

Weight: 530g  
Dimensions: 162\*124\*78 mm



### A82 Recessed Mount

Weight: 475g  
Dimension: Ø168.7\*91.3mm



**Milesight Technology** | [www.milesight.com](http://www.milesight.com)  
Contact Us: [sales@milesight.com](mailto:sales@milesight.com) [support@milesight.com](mailto:support@milesight.com)

Add: 220 NE 51st Street, Oakland Park, Florida 33334, USA  
Tel: +1-800-561-0485

Add: 925, Anyang SK V1 Center, LS-ro 116beon-gil, Dongan-gu, Anvang-si, Korea  
Tel: +82-31-990-7732

Add: Building C09, Software Park Phase III, Xiamen 361024, Fujian, China  
Tel: +86-592-5922772

